

LED LATERNA - 25W

OPTICS-C; RAL7016; 4000 K

Due to the high quality and special optics „LED LATERNA“ achieves much better luminous efficiency, compared to lamps with conventional light sources, which means that we can achieve equal or better illumination at much lower power consumption. Luminous flux and nominal power of the lamp are completely flexible and they can be adjusted accordingly due to the project requirements. The lamp is made of solid, hand-forged and machined, galvanized, and finally powder coated steel. It also has a long life span, complete with the latest built-in electronic equipment.

LED LATERNA luminaire is made in Slovenia.



PRODUCT DATA

General information

Number of light sources	16 pcs Cree XP-G3
Lamp family name	LATERNA
Light source color (CCT)	4000 K
Light source replaceable	Yes
Nominal power	25 W
Nominal luminous flux	2350 lm
LED driving current	500 mA
Luminous efficacy	94 lm/W
Protection class IEC	Safety class I
Connecting	IP66/68 3-pole fast connector
Certification	CE
Light regulation	Prepared for dimming

Optic type outdoor	OPTICS-C
CRI	≥70
Luminaire fixation bolts	Not included
Serviceability class	Luminaire is equipped with serviceable parts - (when applicable): LED module, LED driver, optics, front glass cover and mechanical parts.
Product family name	LATERNA

PRODUCT DATA
Operating and Electrical

Input Voltage	120...277 V
Input Frequency	50 ~ 60 Hz
Power factor λ	0.95/0.90

Controls and Dimming

Dimmable	DALI / StepDIM / AstroDIM
----------	---------------------------

Mechanical and Housing

Housing Material	Galvanized steel, powder coated
Optic material	PMMA
Optical cover	Tempered glass (4 mm)
Mounting device	Pole adapter or Wall console
Fixation type	Post top / Wall mount
Fixation angle	Mounting angle 0°

Approval and Application

Ingress protection code	IP66 [Dust protected, jet-proof]
Mech. impact protection	IK09
Surge Protection	10 kV

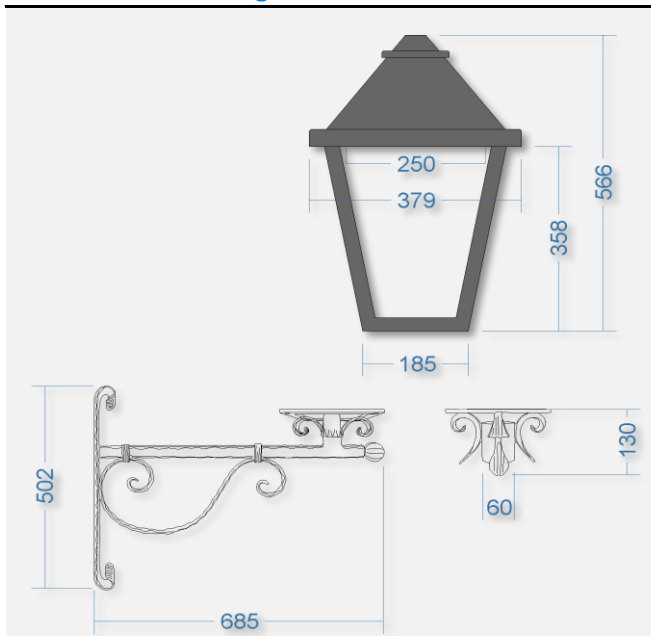
Dimensional drawing

Over Time Performance (IEC Compliant)

LED Useful life L80B10	>100.000 h
------------------------	------------

Application Conditions

Ambient temp. range	-20 to +45 °C
Average ambient temp.	Ta=35 °C

Ordering Data

Full order code	250140254000
Order product name	LED LATERNA - 25W OPTICS-C; RAL7016; 4000 K
Quantity Per Pack	1
Net Weight (luminaire)	8,7 kg
Net Weight (Wall console)	7,0 kg
Net Weight (Pole adapter)	2,1 kg

Mounting options ordering data

Wall console	250000000000
Pole console	250000000001

Photometric data
